

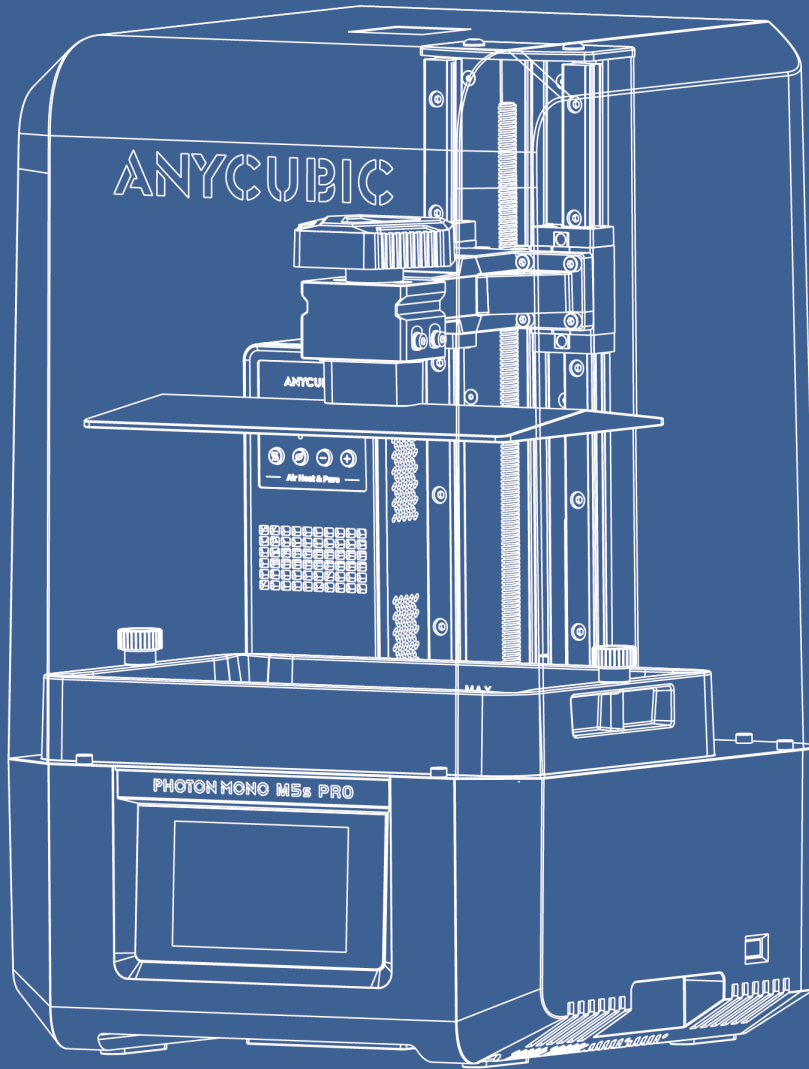

ANYCUBIC



# Photon Mono M5s Pro

 User Manual

Dear customer,

Thank you for choosing Anycubic products.

Maybe you are familiar with 3D printing technology or have purchased Anycubic printers before. However, we still highly recommend you read this manual carefully, as the installation techniques and precautions can help you avoid any unnecessary damage or frustration.

Please visit <https://support.anycubic.com> to contact us if you have any questions. You can also learn more information from the website, such as software, videos, models.



Anycubic support center

**Copyrighted by "Shenzhen Anycubic Technology Co., Ltd ", all rights reserved.**

**Team Anycubic**

# Safety Instructions

Always follow the safety instructions during assembly and usage, to avoid unnecessary damage to the 3D printer or individual injury.



Please contact our Customer Service if you have any issues after receiving the products.



In case of emergency, please immediately cut off the power of the 3D printer and contact our technical support.



UV light is harmful to the eyes; please avoid direct contact. When operating, wear protective equipment such as anti-UV goggles and gloves.



Anycubic 3D printer includes components that can cause injury.



Be cautious when using the scraper, and make sure to orient the sharp parts of machine and tool away from people.



Keep the Anycubic 3D printer and its accessories out of the reach of children.



Vapors or fumes may be irritating at operating temperatures.

Always use the Anycubic 3D printer in an open and well ventilated area.



Do not expose Anycubic 3D printer to any water or rain environment.



Use Anycubic 3D printer in an environment with a temperature of 8°C-40°C and a humidity of 20%-50%. For optimal performance, do not exceed this range. Also, avoid direct sunlight exposure.



Do not disassemble Anycubic 3D printer, please contact technical support if you have any questions.

# Contents

1. Product Overview	5
2. In the Box	7
3. Technical Specification	8
4. Recommended Print Parameters	10
5. Menu Directory	11
6. Preparations	15
7. File Upload	18
8. Print Test	24
9. Resin Exposure Range Finder	30
10. Machine Maintenance	32
11. FAQ	36

# Product Overview

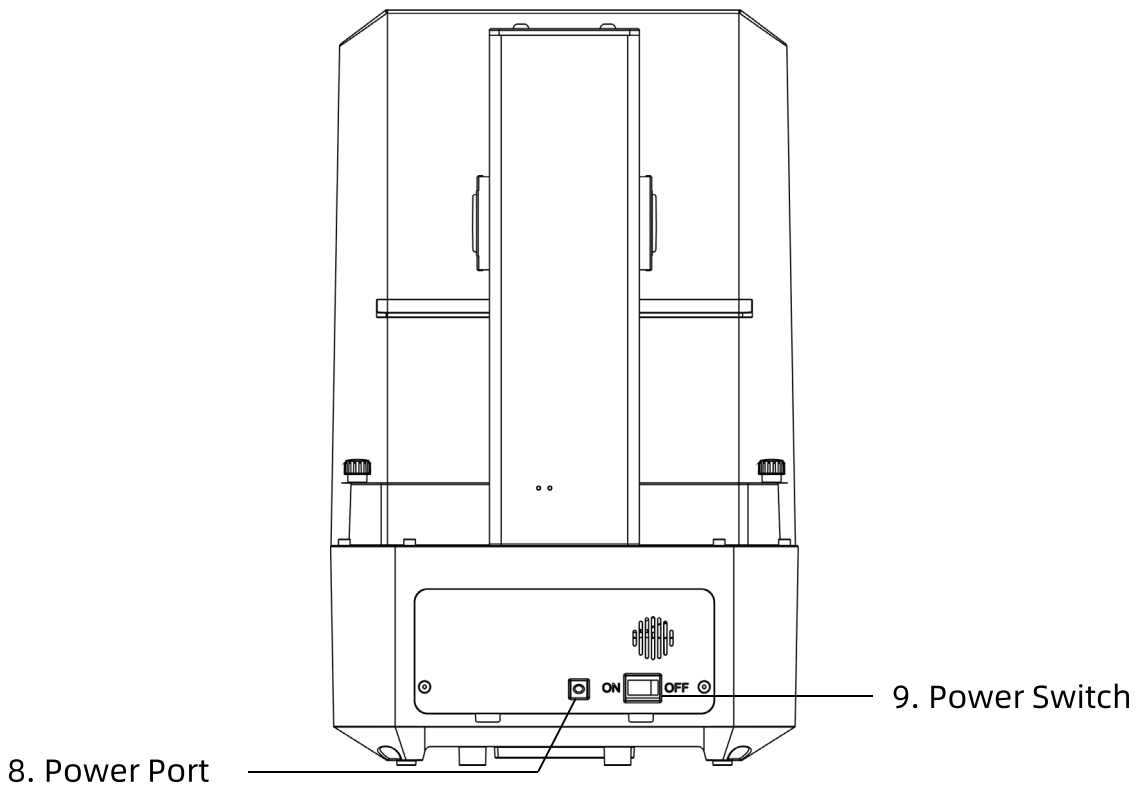
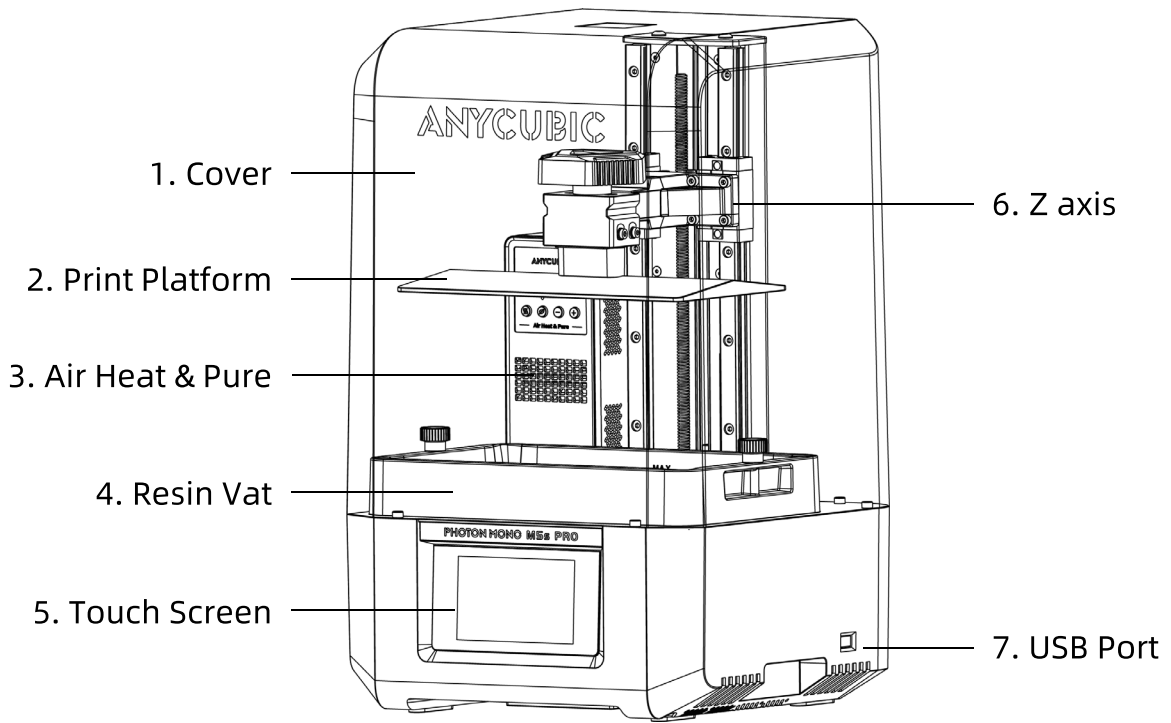

## Air Heat & Pure

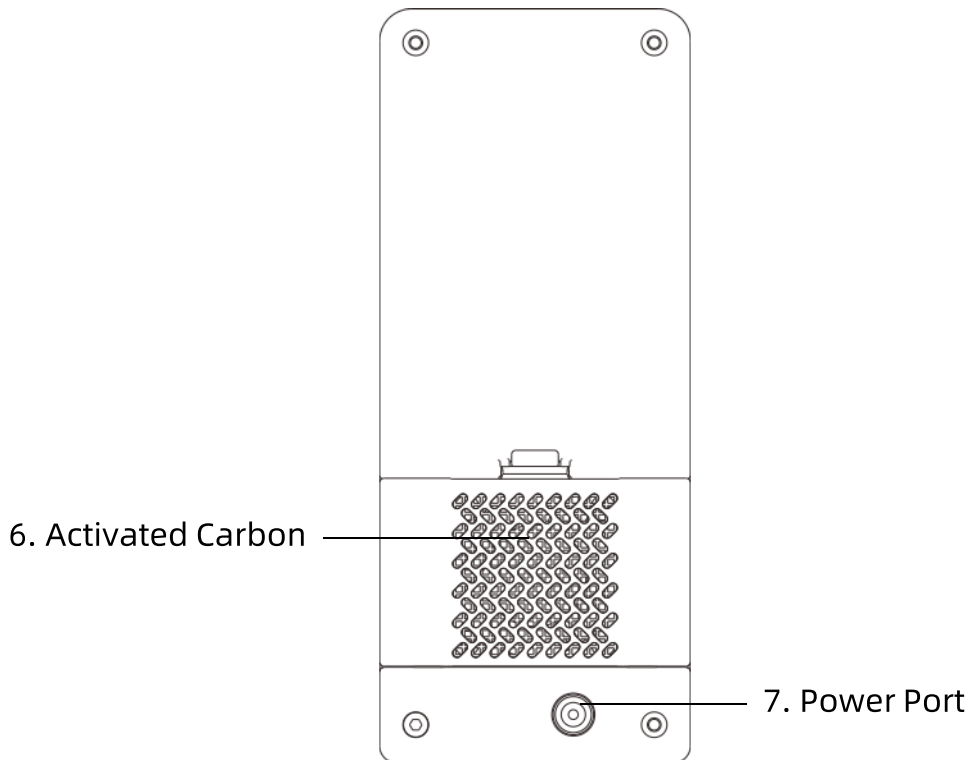
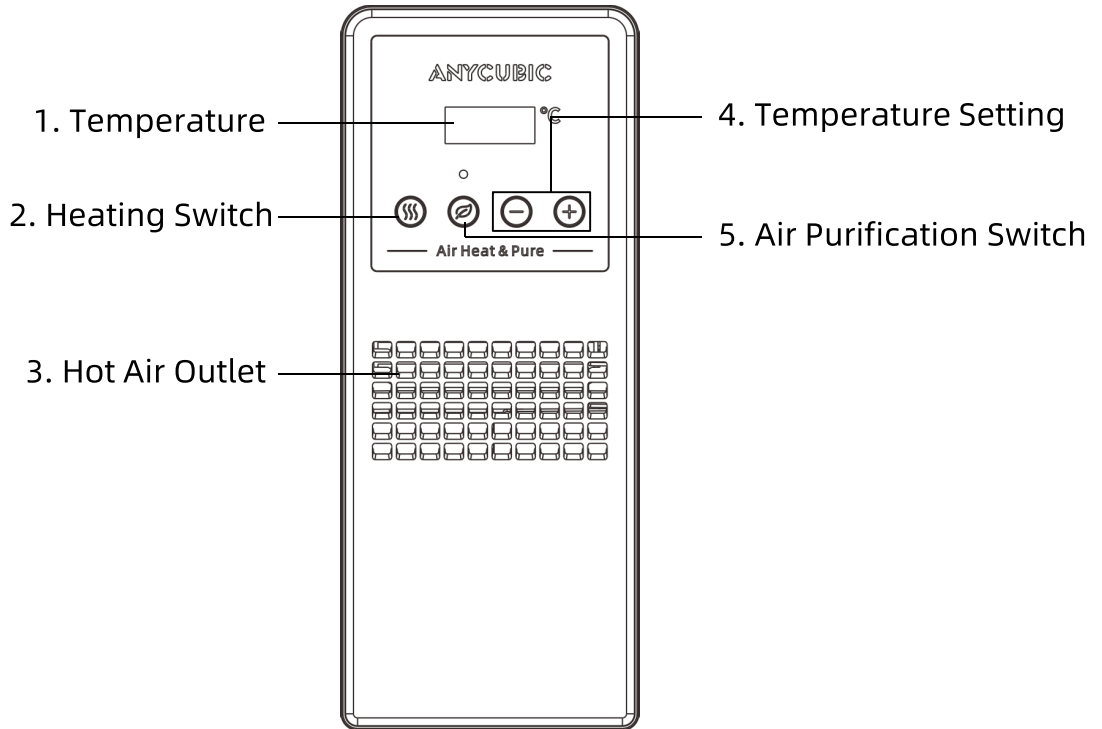

# In the Box

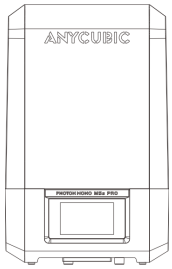

Photon Mono  
M5s Pro

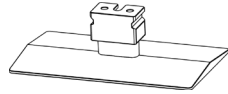

Print platform \* 1

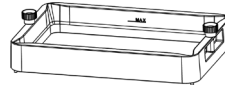

Resin vat \* 1

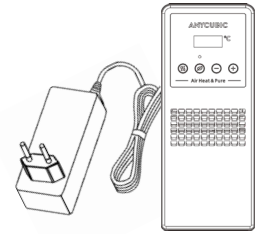

Air Heat & Pure kit



Hex key set

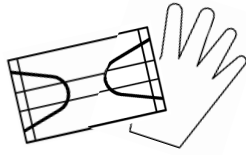

Protective equipment

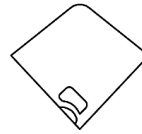

Funnel\*5

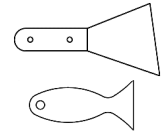

Scraper \* 2



USB drive \* 1

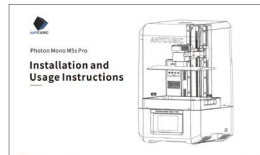

Manual \* 1



Screen protector kit



Leveling Paper

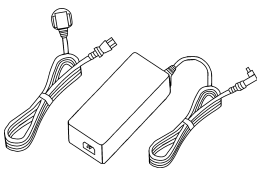

Power cord  
Power adaptor

## Operating System

System	Photon Mono M5s Pro
Touch Screen	4.3-inch Resistive Screen
Software	Anycubic Photon Workshop (also compatible with other software)
Connectivity	USB Drive, WIFI

## Specifications

LCD screen	10.1 inch 14K
Light source	Matrix LED light
XY Resolution	13312 * 5120
Z axis Accuracy	0.01 mm
Suggested Layer Thickness	0.01 ~ 0.15 mm

## Physical Dimensions

Dimension	290 mm(L) *270 mm(W) *460 mm(H)
Build volume	223.78 mm(L) *126.38 mm(W) *200 mm(H)
Weight	9.4 kg

## WiFi

Frequency Range	2.4 G (2.400~2.4835 GHz)
Work Mode	AP, STA, AP+STA mode



## Air Heat & Pure

Control method	Button
Input voltage	24 V
Rated power	55 W
Range of temperature	20 ~ 40 °C
Dimension	55 mm(L) *73 mm(W) *178 mm(H)
Carbon size	39 mm(L) *39 mm(W) *18 mm(H)
Weight	284 g

## Recommended Print Parameters

Parameters Group	① Default Resin_Normal	② Default Resin_Fast	③ High Speed Resin
Layer Thickness	0.05 mm	0.1 mm	0.1 mm
Normal Exposure Time	3.6 s	3.8 s	1.9 s
Off Time	0.5 s		
Bottom Exposure Time	30 s	30 s	10 s
Bottom Layers	5	4	3
Z Lift Distance	8 mm	5 mm	3 mm
Z Lift Speed	6 mm/s	20 mm/s	20 mm/s
Z Retract Speed	6 mm/s	20 mm/s	20 mm/s
Anti-alias	1		
Notice	<p>1.If the print object needs high accuracy, please use <b>group ①</b> and modify the anti-alias level as 16 and the image blur as 3.</p> <p>2. The <b>group ②③</b> apply to the model whose hollowed thickness is no more than 2mm.</p> <p>3. The <b>group ②③</b> can significantly increase the print speed by cases test. To ensure the print success and print speed, do not modify the parameters casually.</p> <p>4. The <b>group ②③</b> must work with the 3rd Gen High-speed release film this printer provided to avoid print failure. The film can be used to print 30000 layers.</p> <p>5. The <b>group ③</b> only apply to Anycubic high speed resin.</p> <p>6. Refer to 18-19 pages for the instructions of parameter groups.</p>		

**--The data above root in Anycubic lab, only for reference.**

# Menu Directory

## Home menu

### Print

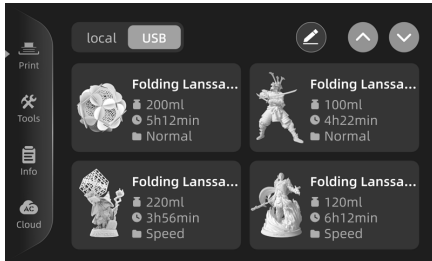

### Tools

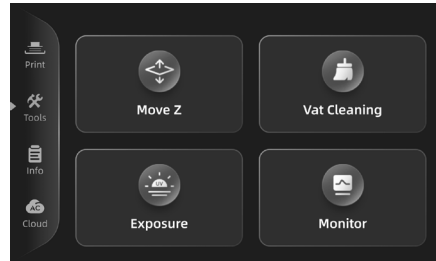

### Information

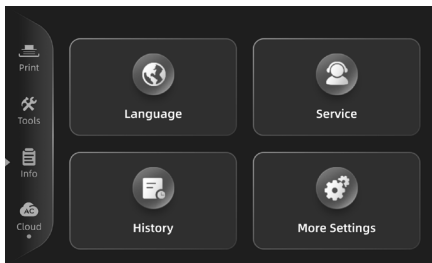

### Cloud

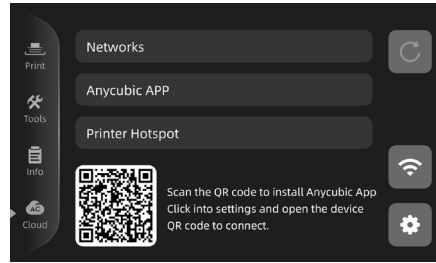

## Print

### Print:

Switch to local/  
USB drive file list

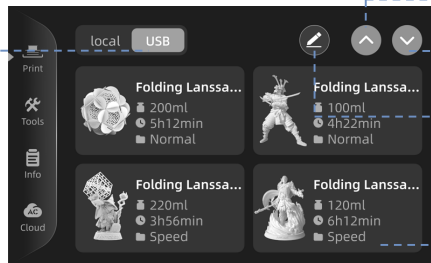

Page up

Page down

Edit files

Enter into the file details

### File Details:

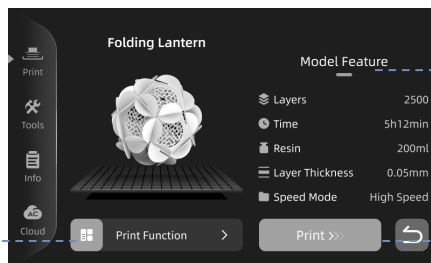

Print job information

Print function setting

Start the printing

# Menu Directory

## Tools

### Move Z:

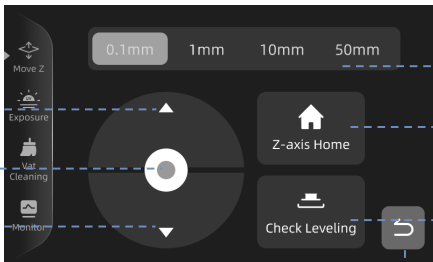

The screenshot shows the 'Move Z' menu with a central joystick and several buttons. The joystick has four directional arrows. Above it are four buttons labeled '0.1mm', '1mm', '10mm', and '50mm'. To the right of the joystick are two buttons: 'Z-axis Home' (with a house icon) and 'Check Leveling' (with a printer icon). A back arrow button is located at the bottom right.

Move the Z axis upwards

Stop moving the Z axis

Move the Z axis downwards

Move Z by 0.1mm /1mm/10mm/50mm

Return to Zero

Move to check the manual leveling effect

Return to the Tools Menu

### Exposure :

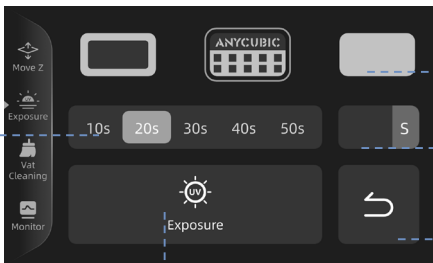

The screenshot shows the 'Exposure' menu. At the top, there is a preview window showing a grid pattern. Below it are five buttons labeled '10s', '20s', '30s', '40s', and '50s', followed by a 'S' button. A central button with a UV light icon is labeled 'Exposure'. A back arrow button is at the bottom right.

Set the exposure time

Choose an image to expose

set the exposure time

Return to the Tools Menu

Start exposure

### Vat Cleaning:

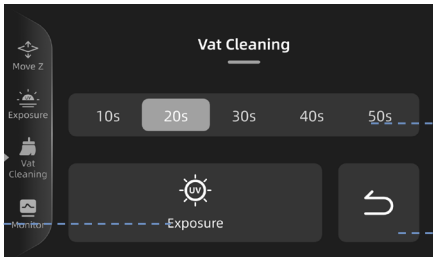

The screenshot shows the 'Vat Cleaning' menu. It features a central button with a UV light icon labeled 'Exposure'. Above it are five buttons labeled '10s', '20s', '30s', '40s', and '50s'. A back arrow button is at the bottom right.

Start exposure

Set the exposure time

Return to Tools Menu

### Monitor:

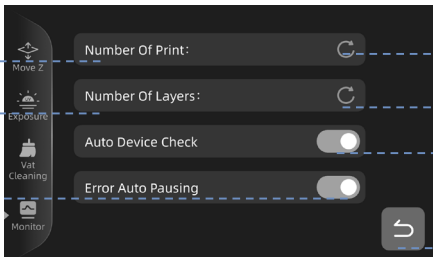

The screenshot shows the 'Monitor' menu. It contains four settings: 'Number Of Print:' with a refresh icon, 'Number Of Layers:' with a refresh icon, 'Auto Device Check' with a toggle switch, and 'Error Auto Pausing' with a toggle switch. A back arrow button is at the bottom right.

Statistics of print times

Statistics of print layers

Enable/disable error automatic pause

Reset the print times

Reset the print layers

Enable/disable auto device check

Return to the Tools Menu

## Information

### Language:



Set the language

Return to the Info Menu

### Service:

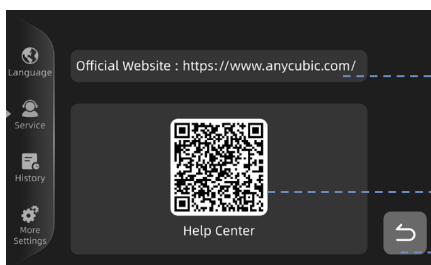

Official website

QR code of support center

Return to the Info Menu

### Information:

Print history

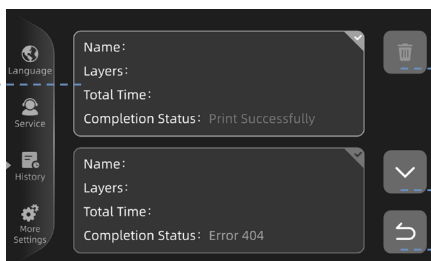

Delete the record

Page down

Return to the Info Menu

### More Settings:

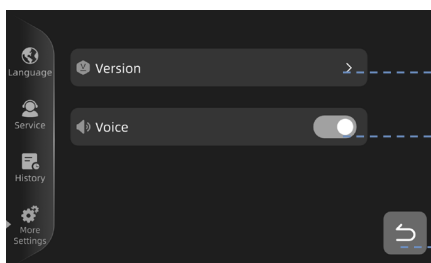

Enter into the version interface

Turn on/off the screen sound

Return to the Info Menu

# Menu Directory

## Version:

Printer system	System		
System version	Version Information		
Serial number	Version Serial Number		Enter into upgrade interface
Printer ID	ID		Return to the More Settings

## Upgrade:

Current firmware version	Current		OTA upgrade
Latest firmware version	Latest		USB upgrade
What's new	Optimization		

## Cloud

### Cloud:

WiFi connection	Networks		WiFi connection status
	Anycubic APP		Reset WiFi status
Printer's hotspot	Printer Hotspot		App connection
			Turn on/ off WiFi module
	Scan the QR code to install Anycubic App Click into settings and open the device QR code to connect.		Enter into the network settings

## Network settings:

Name of the network	WLAN_		
	Server Location	>	Set server
Printer CN	CN		
IP address	IP		QR code of the printer
MAC	Mac		Return to the Cloud

# Preparations

1. Turn on the printer and then wait for the auto device check. The printer automatically checks the hardware help you shooting the troubles and reduce the print failure. When there is an error, the printer will pop up the error QR code. Please scan the code and follow the guide.

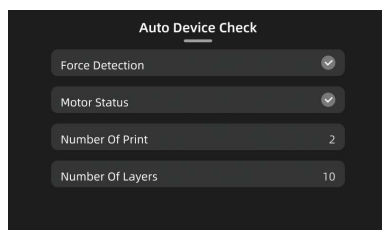

## Force Detection

Check whether the force sensor that affects the resin volume detection and leveling detection works.

## Motor connection

Check the connection of motor to ensure it works properly.

If you disable the auto device check, the printer will not automatically check the hardware condition.

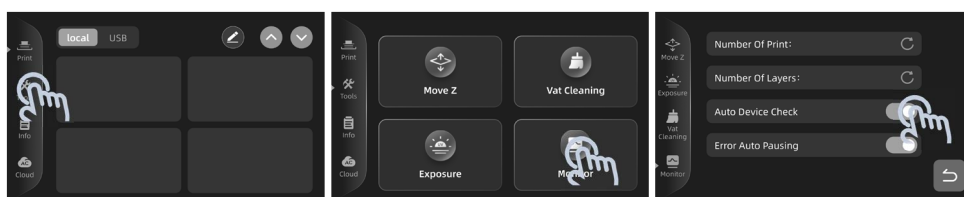

Disable auto device check

2. Raise Z axis by 100mm.

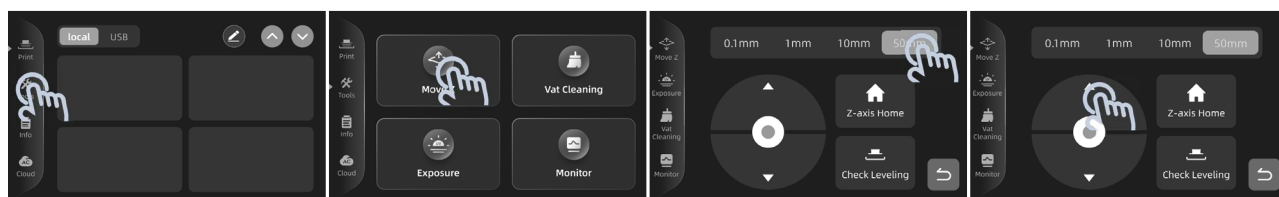

Click 2 times

# Preparations

## 3. Install the screen protector.

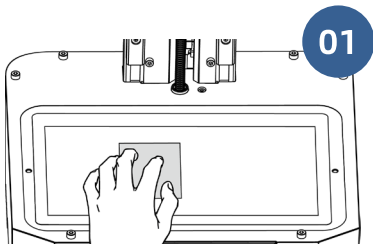

Peel off the protective film and clean the LCD screen with tool kit

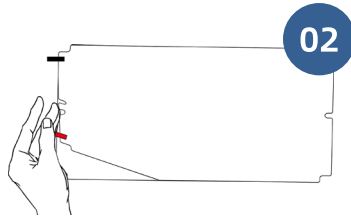

Peel off the film ①

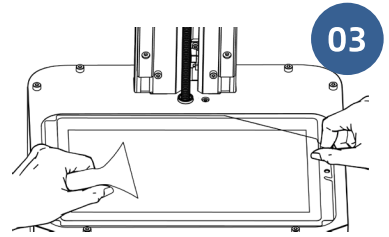

Align locating holes and squeeze out air bubbles

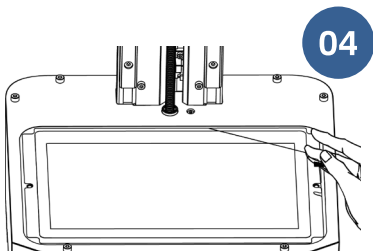

Peel off the film ②

## 4. Install the print platform.

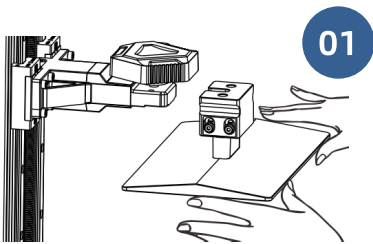

Push the platform onto the platform carrier

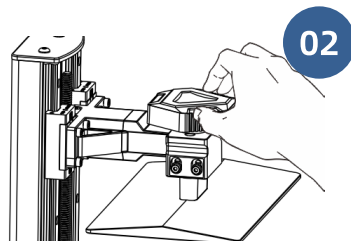

Tighten the knob

## 5. Choose an exposure image to test.

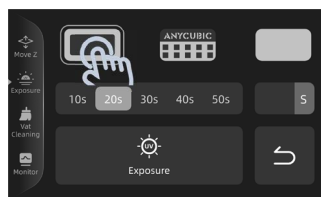
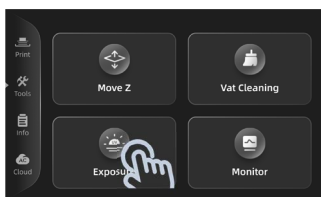

The white part is exposure area



# Preparations

## 6. Install the resin vat.

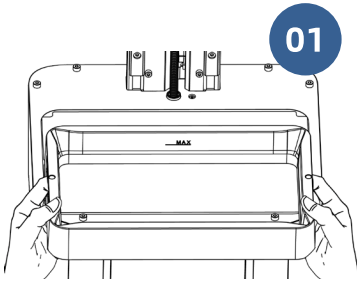

Put the resin vat with its feet stuck in locating holes

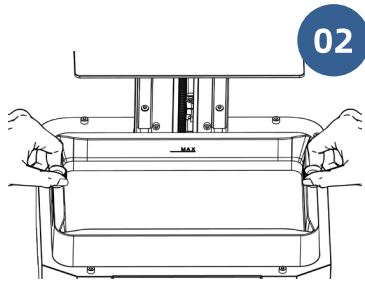

Tighten two knobs

## 7. Install Air Heat & Pure.

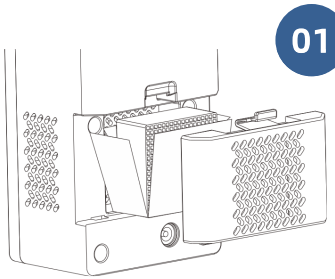

Remove the package of carbon

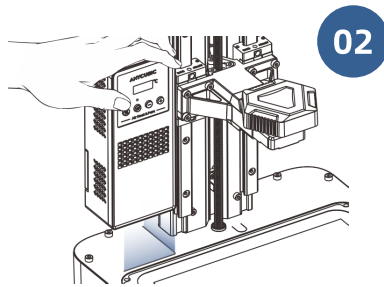

Peel off the backing paper from bottom adhesive, and align the positioning line to secure Air Heat & Pure

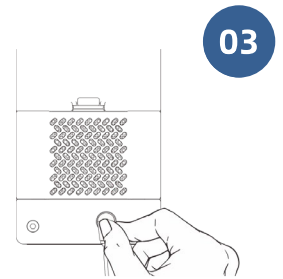

Connect to the power

## USB

1. Use Anycubic Photon Workshop software to process the 3D model file. The installer and instructions is saved in the USB drive.
2. When you set the parameters in Anycubic Photon Workshop, there are three groups of parameter which can be apply to the print with different needs.

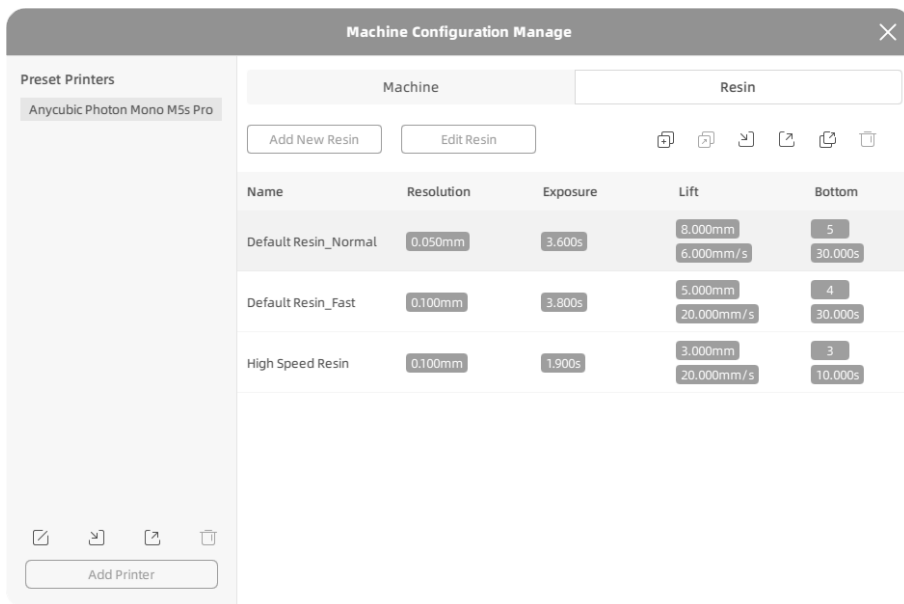

Choose the parameter group according to the personal requirement

### ① Default Resin\_Normal

Apply to the Anycubic resin with normal printing speed. If the print object needs high accuracy, please modify the anti-alias level as 16 and the image blur as 3.

### ② Default Resin\_Fast

Apply to the Anycubic resin with fast printing speed. The layer thickness is 0.1mm. Optimizing the Z-axis motion control increases the print speed.

## ③ High Speed Resin

Only apply to the Anycubic high speed resin with the fastest printing speed. The layer thickness is 0.1mm. Optimizing the Z-axis motion control increases the print speed.

Notice for parameter group②③:

1. The parameters apply to the model whose hollowed thickness is no more than 2mm.
2. The parameters must work with the 3rd Gen High-speed release film this printer provided to avoid print failure. The film can be used to print 30000 layers.

3. Save the sliced file to USB drive.

4. Then, insert the USB drive to the printer.

USB drive:

- ① It is recommended that use the USB drive we provide. If you are using your own USB drive, please ensure that it is formatted to **FAT/FAT 32** and has a memory size of less than **32G**.
- ② To ensure proper file reading, please put print files in the root directory of USB drive.

## Cloud

Please connect the printer to Anycubic App first for remote uploading and monitoring.

1. Check whether it is global server. If not, click to switch to the global server and wait for the printer restarting.

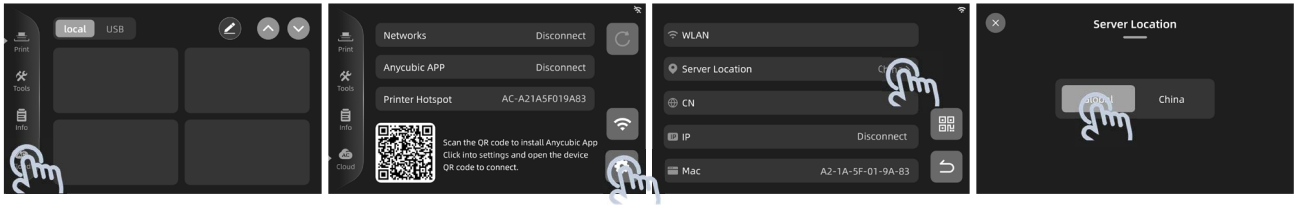

2. Reset WIFI connection.

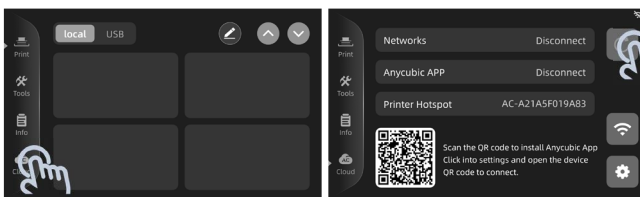

3. Please search "Anycubic" in App Store or Goolge Play, or scan the QR code on the printer, to download Anycubic App. Then, sign up and sign in.

4. Add a printer in Anycubic App.

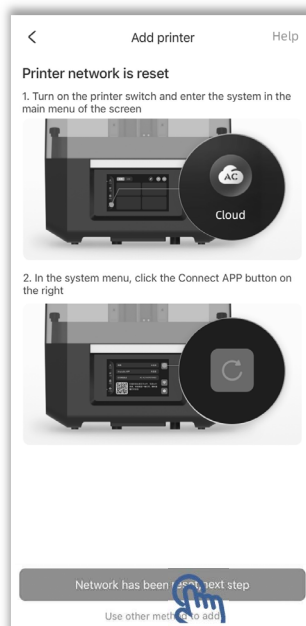

# File Upload

## 5. Connect to printer's hotspot.

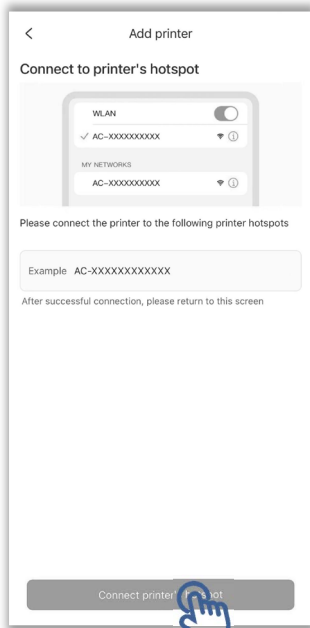

Check the printer's hotspot

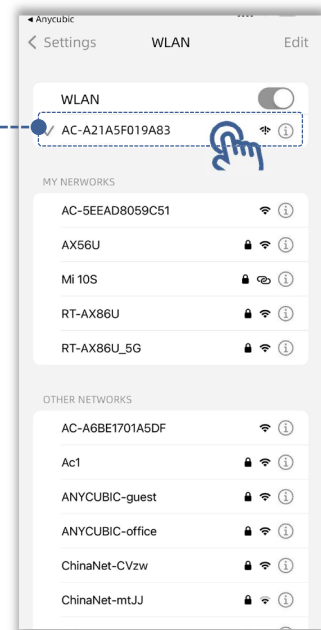

Select the printer's hotspot

## 6. Return to App, connect the printer to the network.

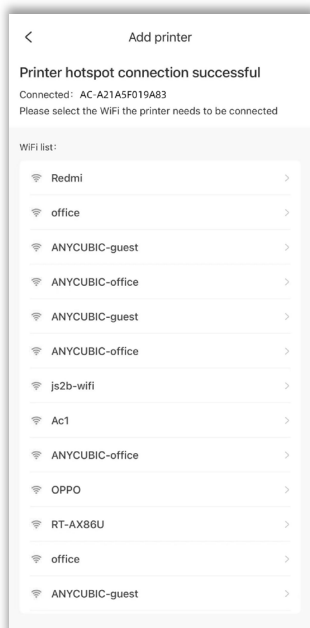

Select WIFI

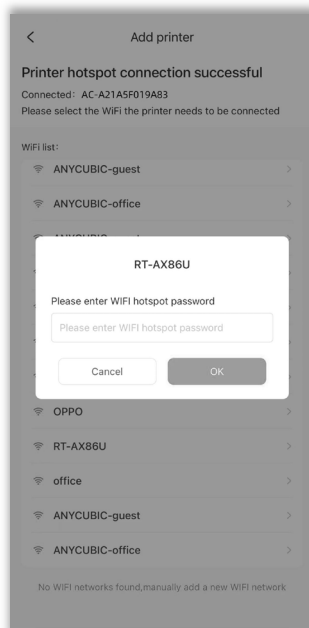

Enter in password

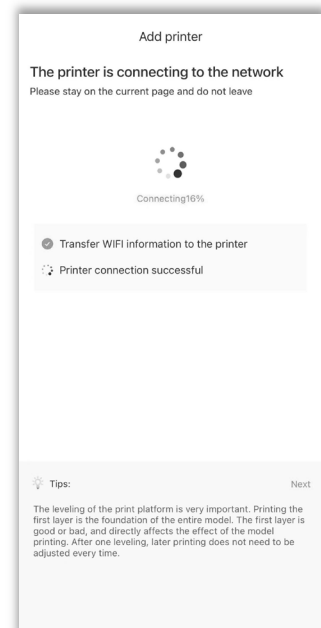

### Notice:

- ① The location and local network must be allowed to use during connection.
- ② Please ensure the connection to printer's hotspot during the network connection to avoid connection failure.

7. Printer is added successfully. Search model or upload the model files.



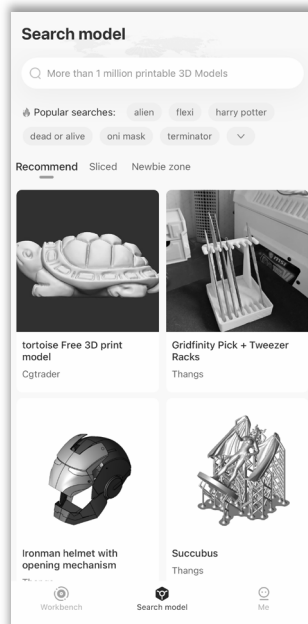
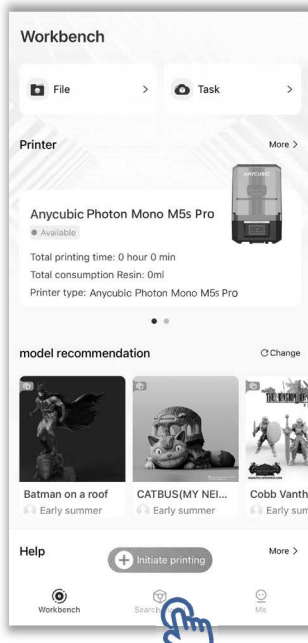

- Search model

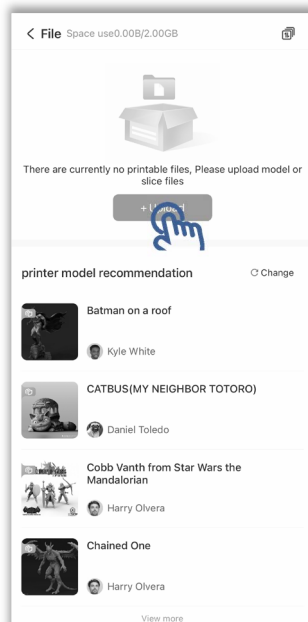
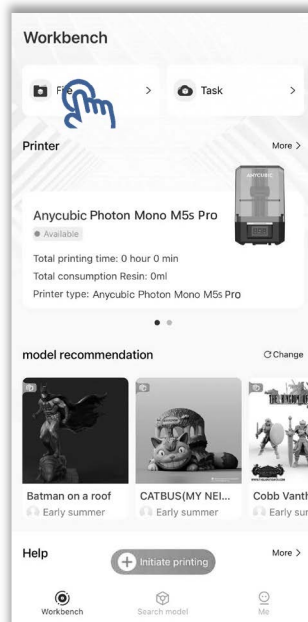

- Upload the model files

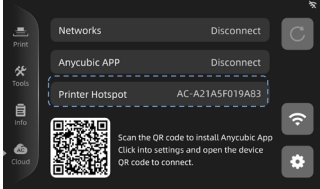

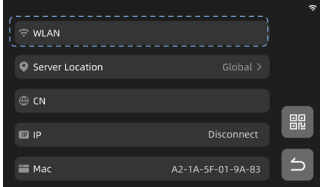
## Cloud Connection Troubleshooting

Issues	Troubleshooting	Solution
<p>Fail to connect to printer's hotspot in App</p>	<p>Check whether it is printer's hotspot</p> 	<p>If not, please reconnect to the printer's hotspot.</p>
<p>The printer prompts that <b>WiFi connection failed</b></p> 	<p>Check whether the WIFI and its password is correct</p>	<p>If not, please click  in Cloud menu on the printer to reset WIFI. Then, connect the printer to network again.</p>
	<p>Check whether WLAN on printer is the WIFI</p> 	<p>If not, please click  in Cloud menu on the printer to reset WIFI. Then, connect the printer to network again.</p>
	<p>Check whether the WIFI network is unavailable</p>	<p>Join an available network. Click  in Cloud menu on the printer to reset WIFI. Then, connect the printer to network again.</p>

## Connection Status

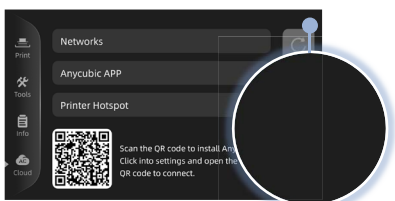

WiFi module off  
disconnected



WiFi module on  
disconnected



WiFi module on  
connected

## Resin Preparations

\*The release film on the resin vat is consumable. Please pay attention to the status of release film on the touch screen and replace the film timely.

Please check the release film carefully before and after every printing. If the film is broken, replace it immediately to avoid further damage to the machine.

1. Slowly pour resin into the vat with resin level not exceeding the vat's maximum scale.

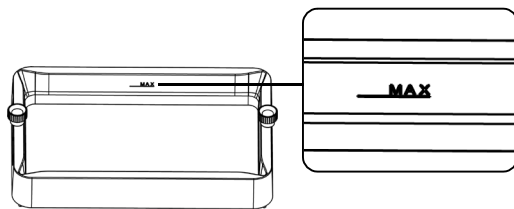

2. When the ambient temperature is below 20 °C, it may cause the detachment of printed bottom or partial loss of printed objects. At this time, you can use Air Heat & Pure to raise the printer's ambient temperature to improve the printing effect.

① Turn on Air Heat & Pure.

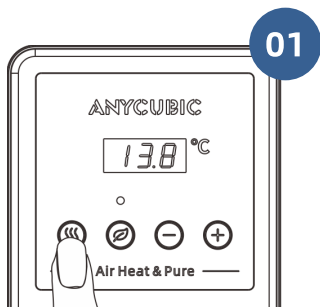

Start heating

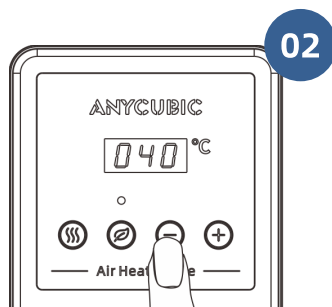

Set the temperature  
(Recommended  $\geq 35^{\circ}\text{C}$ )

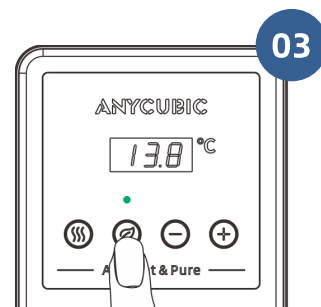

Start air purification  
(optional)

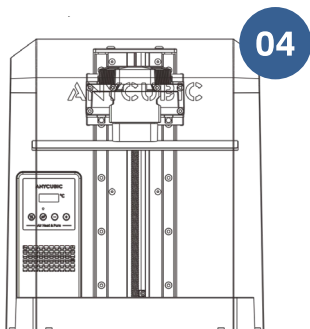

Put on the cover



② Enable the delay start and set the waiting time. The printing will start when the countdown is over. The delay start is disabled by default.

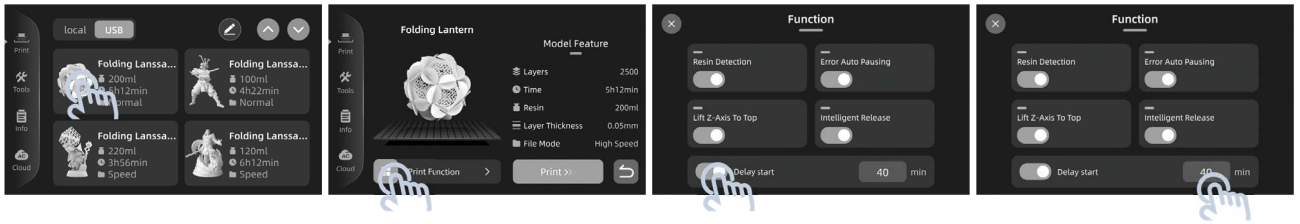

Please refer the waiting time as followed:

Ambient temperature	Delay start
5~10 °C	60 min
10~25 °C	30 min

Notice: High speed mode (sliced file) requires high speed resin! Otherwise, the print may fail.

## Print File

### Print USB drive file

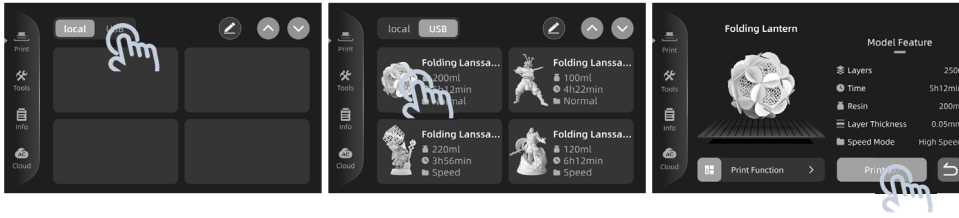

### Remote print

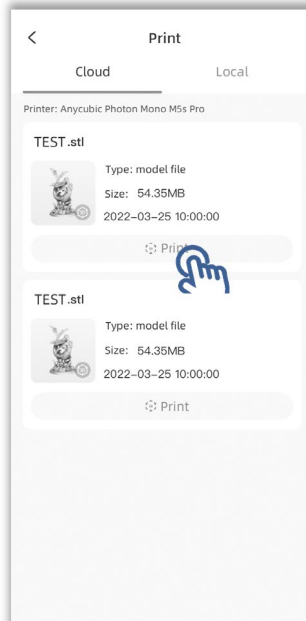
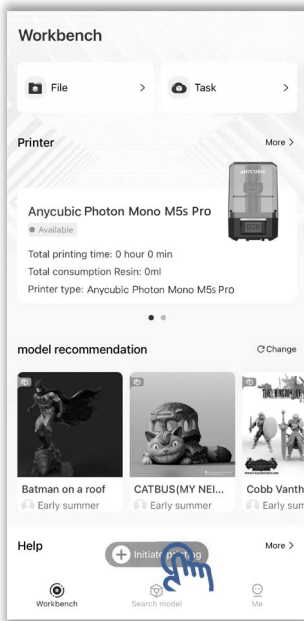

## Before printing

1. The printer checks the hardware condition, resin volume and leveling before each print job. When there is an error, the printer will pop up the error QR code. Please scan the code and follow the guide.

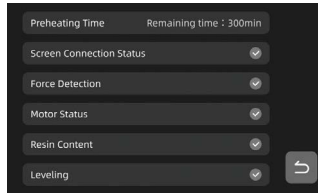

### Waiting Time

If the delay start is enabled, the printing will start when the countdown is over.

### Resin

① Check whether the volume of resin in the vat is sufficient to finish the print job. Usually, the required resin volume is a little more than the resin volume estimated by the slice software. If it prompts that the resin volume is not enough, please add resin and then check it again.

② Check if there are solid residues of more than 3mm in the vat. If residues are detected, please clean the vat and check again.

### Leveling

Check the leveling to avoid layer separation or other errors.

2. If the delay start is enabled, you can choose to skip the countdown if necessary. Please be cautious, as low ambient temperature and insufficient heating time may lead to print failure.

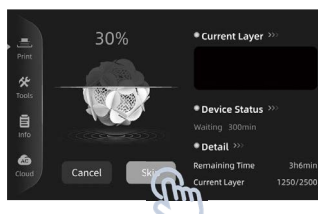

3. The function you don't need can be disabled before printing.

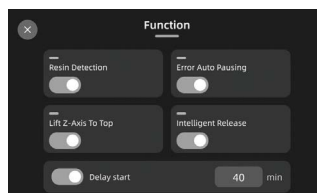
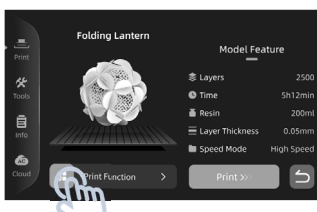

## In Printing

**Error Auto Pausing:** During printing, the printer automatically monitors the conditions which may cause print failure and prompt the error to the customers in case resin is wasted or even damage the printer. When the printer detects an abnormal condition, it will pause the print job automatically and pop up the error report. Please check the sliced file and the model according to the report.

### Bottom non-stick detection

It monitors the condition that model does not stick to the print platform.

When the printer detect the model does not stick the platform, please check the bottom exposure time of the file.

**Intelligent Release:** The function can improve the printing success rate by optimizing algorithm. Enabling intelligent release while printing with the default resin\_normal parameter group can also increase printing speed. The function is enabled by default.

The function you don't need can be disabled before printing.

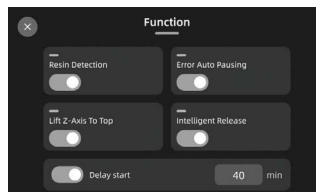
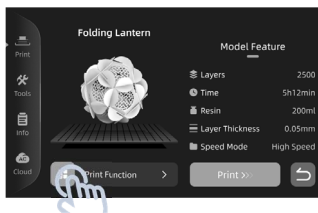

## After Printing

1. When the printing is finished, resin may be cured partly in the vat. Please set to Vat Cleaning and remove the residue.

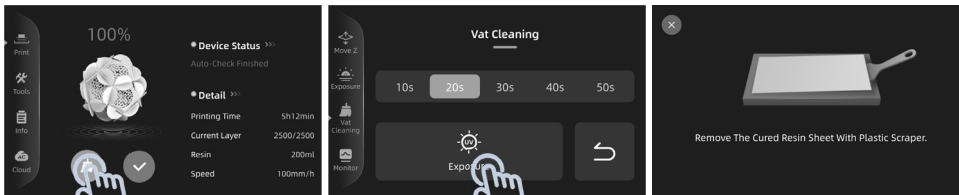

Remove resin sheet  
by plastic scraper

## 2. Finishing

- After printing, remove the platform when resin stop dropping from the platform. Remove the model by metal scraper and then wash it with 95% alcohol or other detergent. It may need post-curing to achieve better hardness by being exposed directly to sunlight or a UV-curing machine.
- After printing, there might be some cured resin left in the vat. Please clean the vat timely, and filter the remaining resin by a funnel. Otherwise, it may cause damage to the release film or LCD screen. If you do not use the resin now, it is recommended to store it in an airtight container away from light.

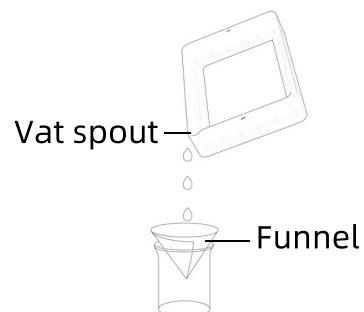
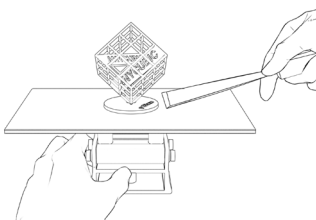

# Resin Exposure Range Finder

“R\_E\_R\_F” is an abbreviation for “Resin Exposure Range Finder”. This function is used to find out the optimal exposure parameters for different resins.

1. Import the R\_E\_R\_F file which is saved on USB drive into the slicing software. There are eight models in the file. The exposure time for model 1 is equal to "normal exposure time (s)" of the file, and the exposure time for other models will be increased by an increment of **0.25 s**.

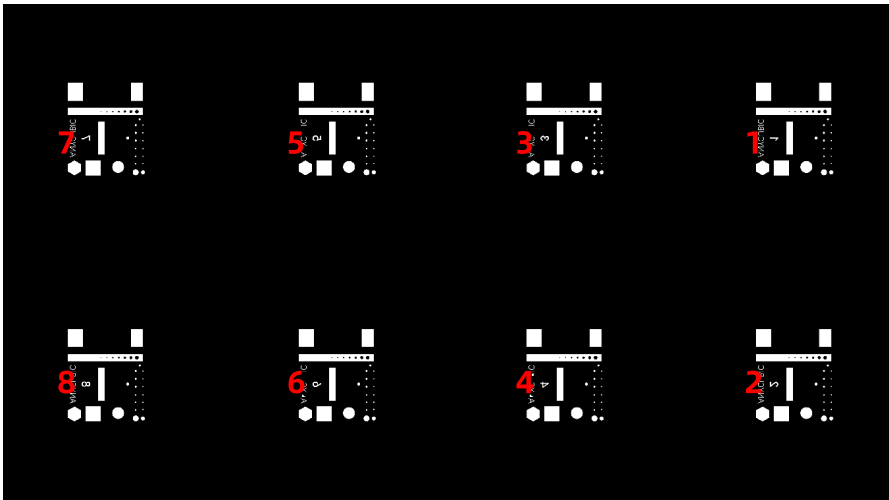

The numbers on the models indicate their order

2. According to the personal requirement, adjust the exposure time of the models by modifying "normal exposure time (s)" of the file. When exposure time for Model No. 1 is changed, the exposure time for other models will be increased by an increment of **0.25 s**.

For example, when normal exposure time is set to 1.5 s, the exposure time for Model No.1-8 is: 1.5 / 1.75 / 2 / 2.25 / 2.5 / 2.75 / 3 / 3.25 s.

3. After printing, remove and clean the models. Compare the print effect of models and choose the model's exposure time that meets your needs as the print parameter. Take a comparison of model A&B as an example.

# Resin Exposure Range Finder

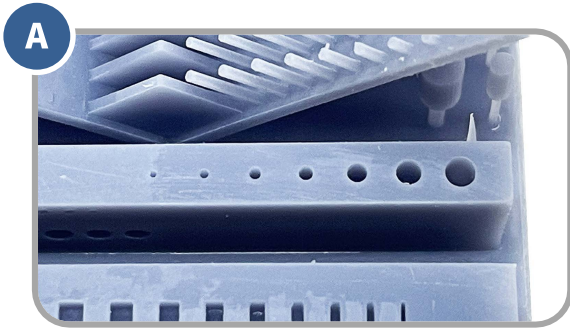

More holes

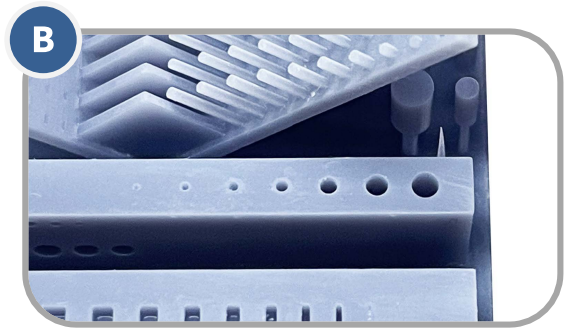

Less holes

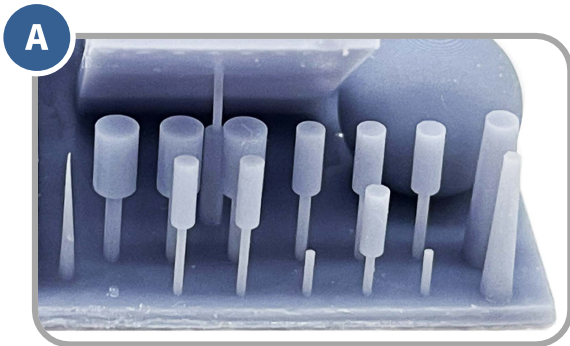

Less cylinder

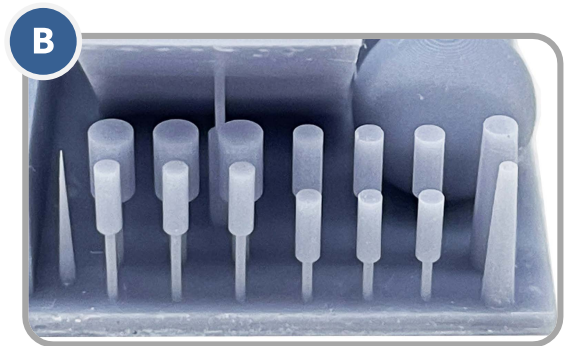

More cylinder

- Model A has more holes and fewer cylinder. If you print by the parameter of model A, more details of model can be printed with high risk of failure.
- Model B has fewer holes and more cylinder. If you print by the parameter of model B, model may be printed successfully yet with some details lost.

In addition, you can compare the bridges, needles or other parts to choose a proper model and find the parameter. If none of them can be chose, adjusting the "normal exposure time (s)" is suggested.

**Notice: DO NOT change the file name of "R\_E\_R\_F", because Anycubic 3D printer can only recognize THIS file name to run this function. Also, do not name other file as "R\_E\_R\_F".**

## Leveling

The printer has been designed requiring no leveling for the first use. However, please re-level the printer in the following scenarios:

- The print platform has been fallen to the ground.
- Changing new print platform or LCD screen.
- The printed object sticks to the resin vat instead of the print platform.

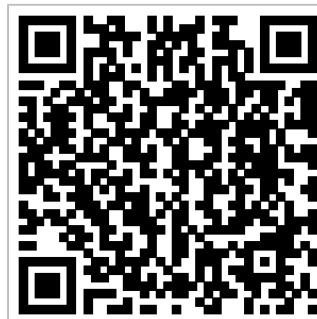

Scan the QR code for the leveling tutorial

**Please follow the steps below to install and re-level.**

1. Install the print platform.

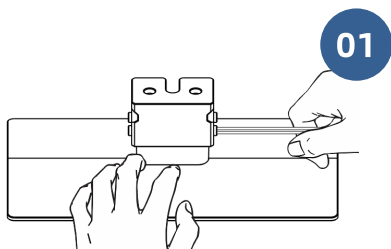

Loosen the four leveling screws

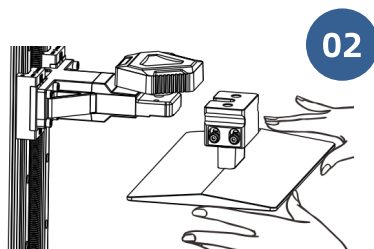

Push the platform onto the platform carrier

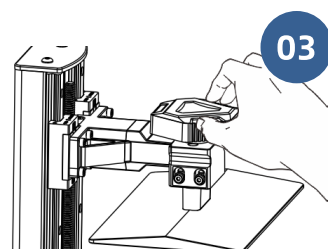

Tighten the knob

2. Leveling.

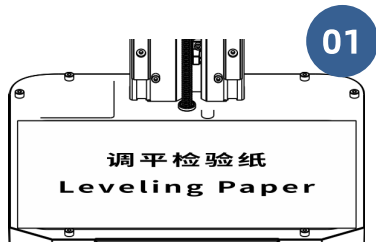

Place the leveling paper (included) on the LCD screen

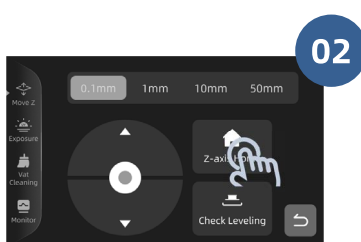

Click "Z-axis Home"

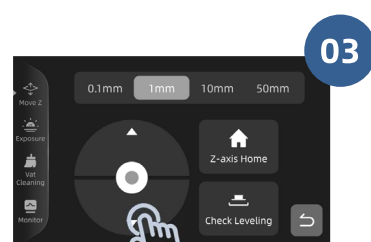

Lower Z axis by **1mm**



# Maintenance

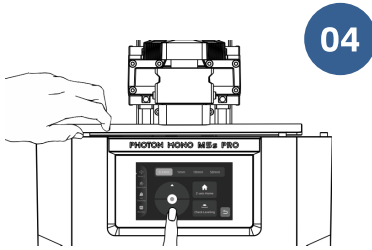

If the print platform shakes with light press, lower Z axis by **0.1mm** each time

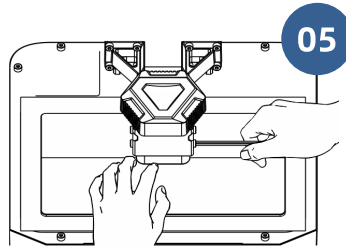

Lower until there is resistance when pulling out the leveling paper, hold the platform and tighten the four screws

3. Check whether the leveling is successful. If it does not match the result shown below, please loosen the four leveling screws and follow the step2 to re-level .

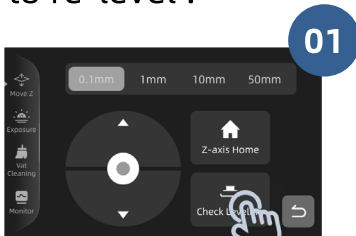

Click "Check Leveling"

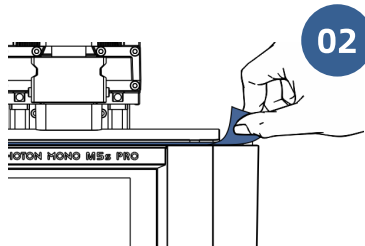

There is a significant resistance when you pull the leveling paper

## Resin Vat Maintenance

- **Remove the cured resin from release film:** Set Vat Cleaning and then remove the cured resin sheet to protect the film. Do not use sharp objects to scrape off the residues on the film.

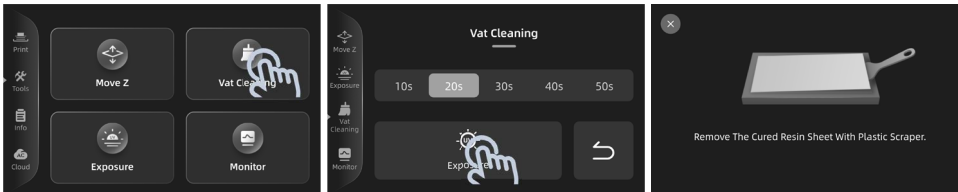

Remove resin sheet by plastic scraper

- **Release film replacement:** The statistics of print times and print layers are shown in Monitor interface. Please check them and replace release film timely to avoid print failure or even the damage to printer.



Replace release film at this time

Click reset button after replacement

- If you do not use the resin for over two days, store it in an airtight container away from light.

## Firmware Upgrade

Check whether the current firmware needs update. "Optimization" shows what's new in the latest firmware.

- **USB upgrade:** Visit the official website to download the installer and save it to a USB drive. Then, insert the USB drive to printer to upgrade.
- **OTA upgrade:** If the network is connected, directly upgrade by OTA.

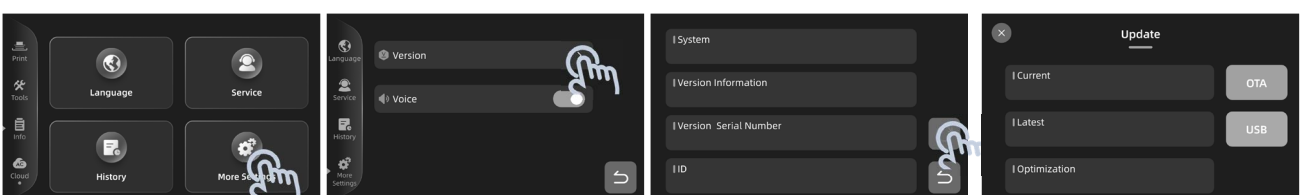

OTA / USB upgrade

## Z-axis Maintenance

If Z axis makes a noisy sound, please apply lubricant to Z lead screw.

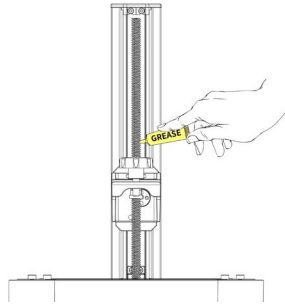

## Cleaning

- **Clean the print platform:** Clean platform with alcohol and paper towel.
- **Protect LCD screen :** If the resin cured on screen protector, please replace it immediately to protect LCD screen.
- **Clean the body of printer:** Clean the body of the printer with alcohol.

## Activated Carbon

- **Service life:** The activated carbon filter can be used for 3~6 months.
- **Reuse:** Expose the used carbon to the sun or a well-ventilated place to dissipate the odor until the carbon is replaced.

## Model do not stick to platform

- Bottom exposure time is insufficient. Please increase the exposure time.
- Contact area between the model and platform is small. Please add a raft.

## Layer separation or splitting

- The machine is not stable during printing.
- The release film is not tight enough or needs a replacement.
- The printing platform or resin vat is not tightened.
- The lift speed is too fast.
- The model is hollowed without punching.

## Layer shift

- Add supports.
- Reduce the lift speed.

## Floccules left in resin vat or attached to models

- The exposure time is too long. Reduce the normal exposure time and bottom exposure time.

Thank you for purchasing Anycubic products! Under normal usage and service, the products have a warranty period of up to one year. Please visit Anycubic support center([support.anycubic.com/en](https://support.anycubic.com/en)) to report any issues with Anycubic products. Our professional after-sale service team would respond within 24 hours and solve the issues.